

GRUPO  
**IGPS**

**CI25003 (2) OA25067 01 02 v1.0**

Presentación Técnico

Cobot Automatización Resinado y  
Decorado de Balones

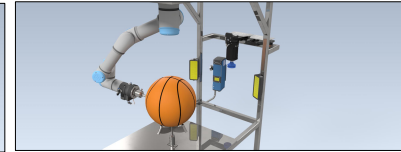
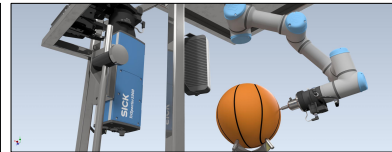
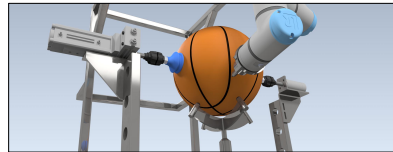

9734333920

**IGPS**

Empresas:

Representaciones / Alianzas Estratégicas:



**TROAX**

**IGPS** ROBOTICA

**Arizens**

**XOLERTIO**

Opcion 1  
Estación de Trabajo Colaborativa

---

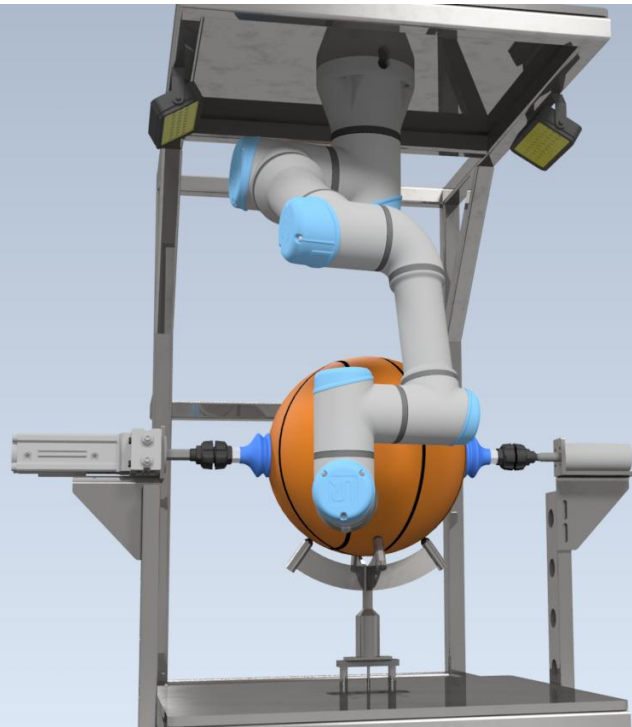

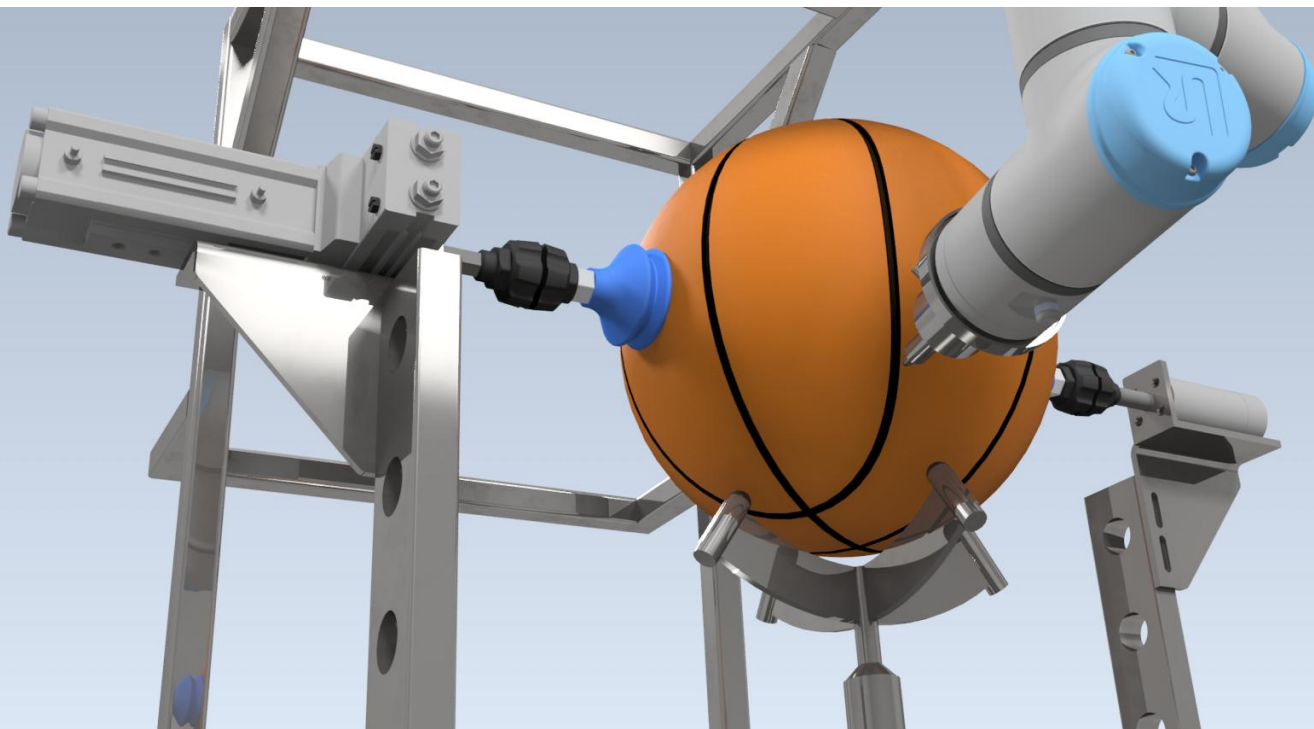

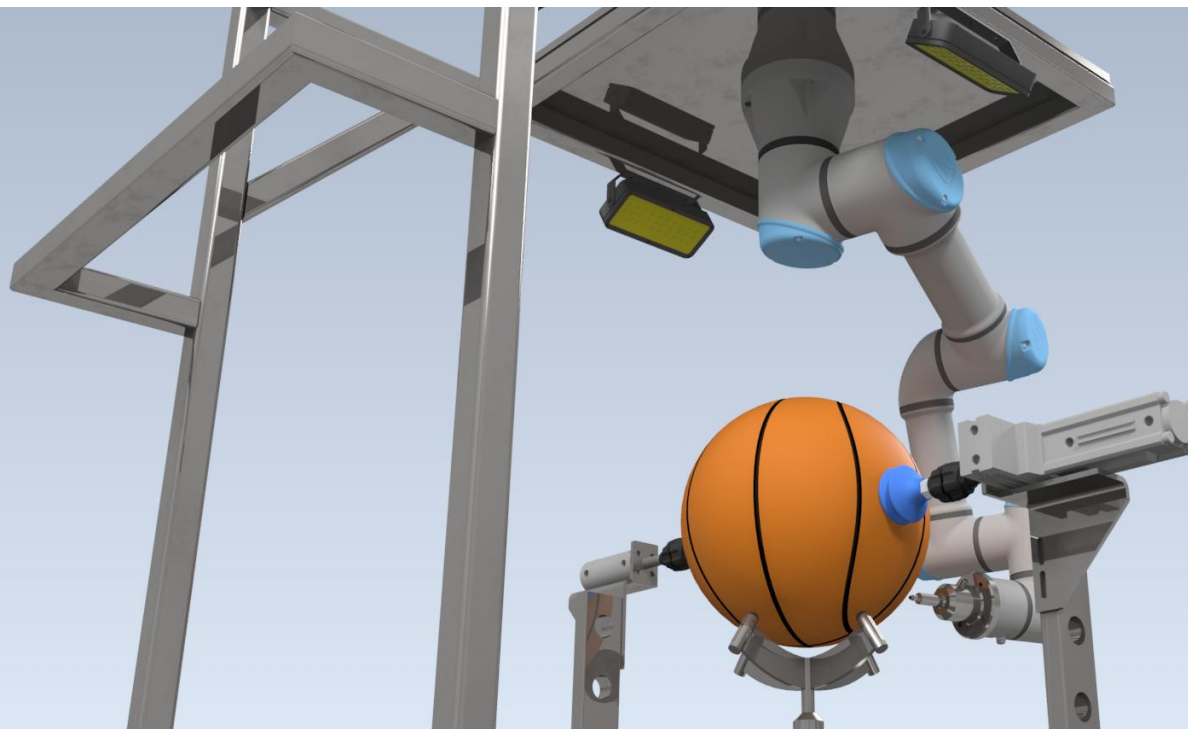

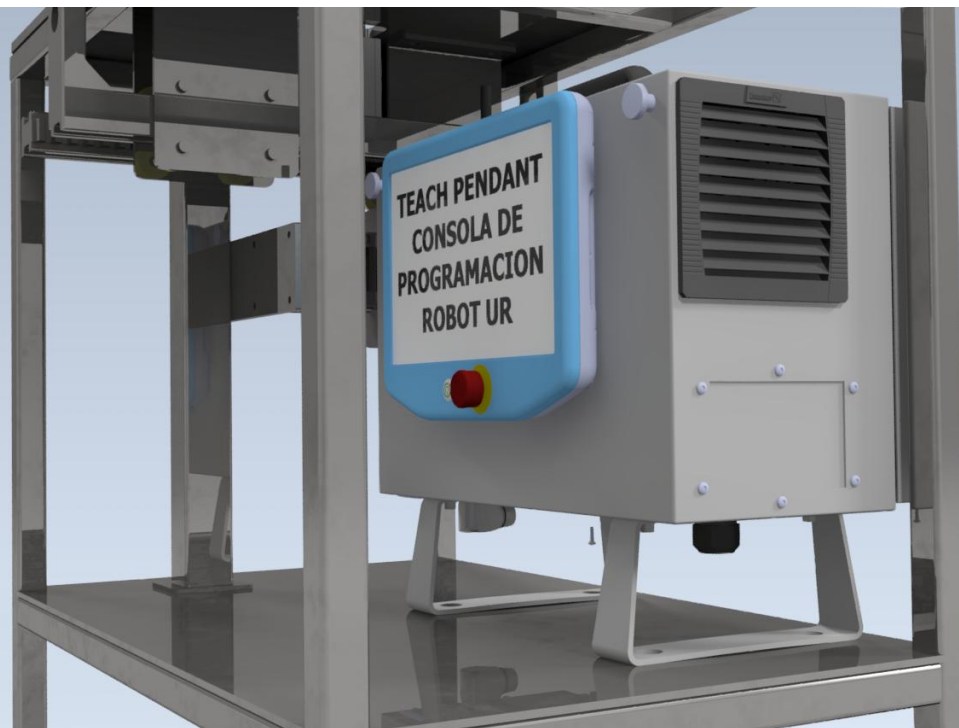
IGPS<sup>®</sup>

Empresas:

Representaciones / Alianzas Estratégicas:



TRDAX

IGPS<sup>®</sup> ROBOTICA

Arisens

XOLERTIO

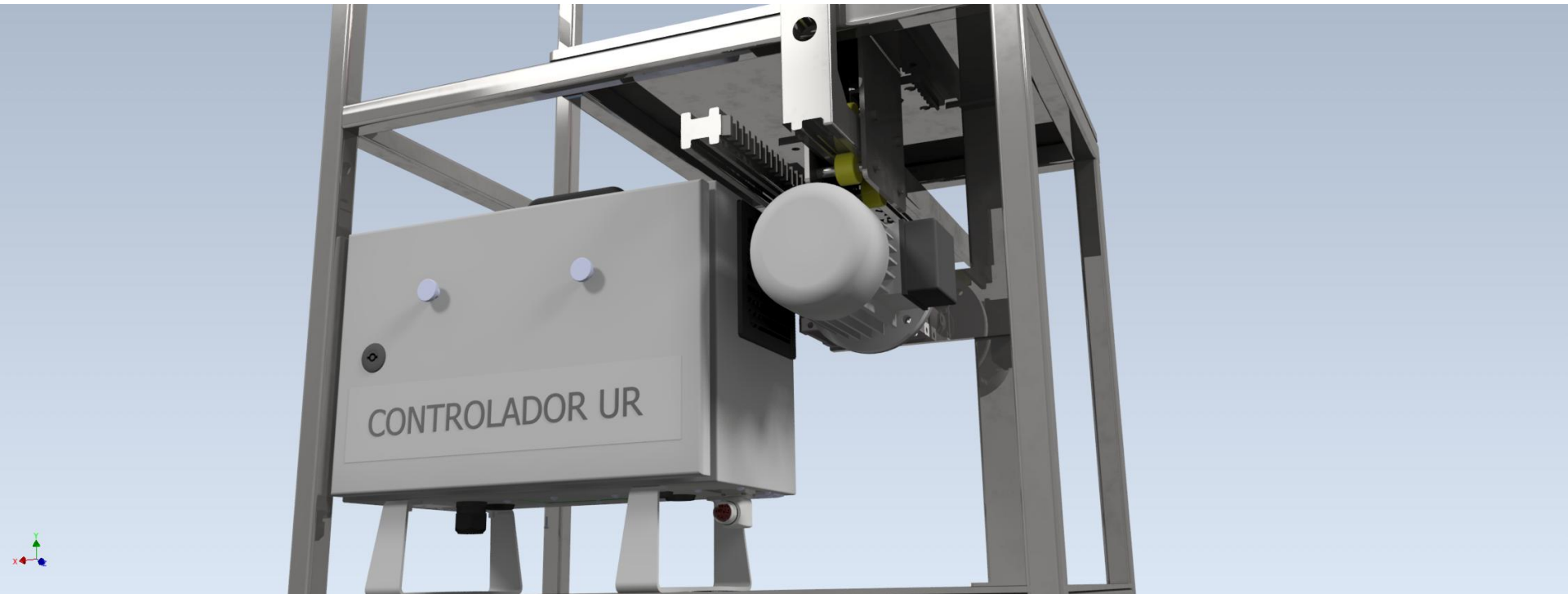

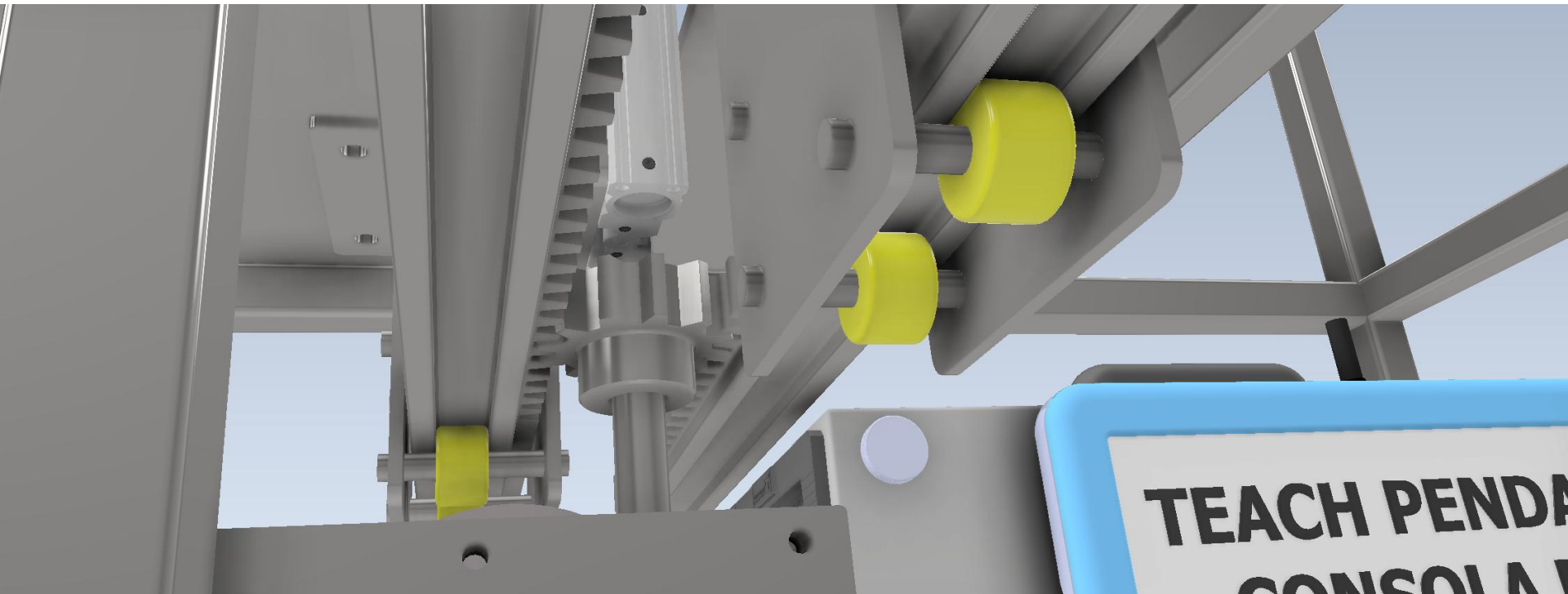

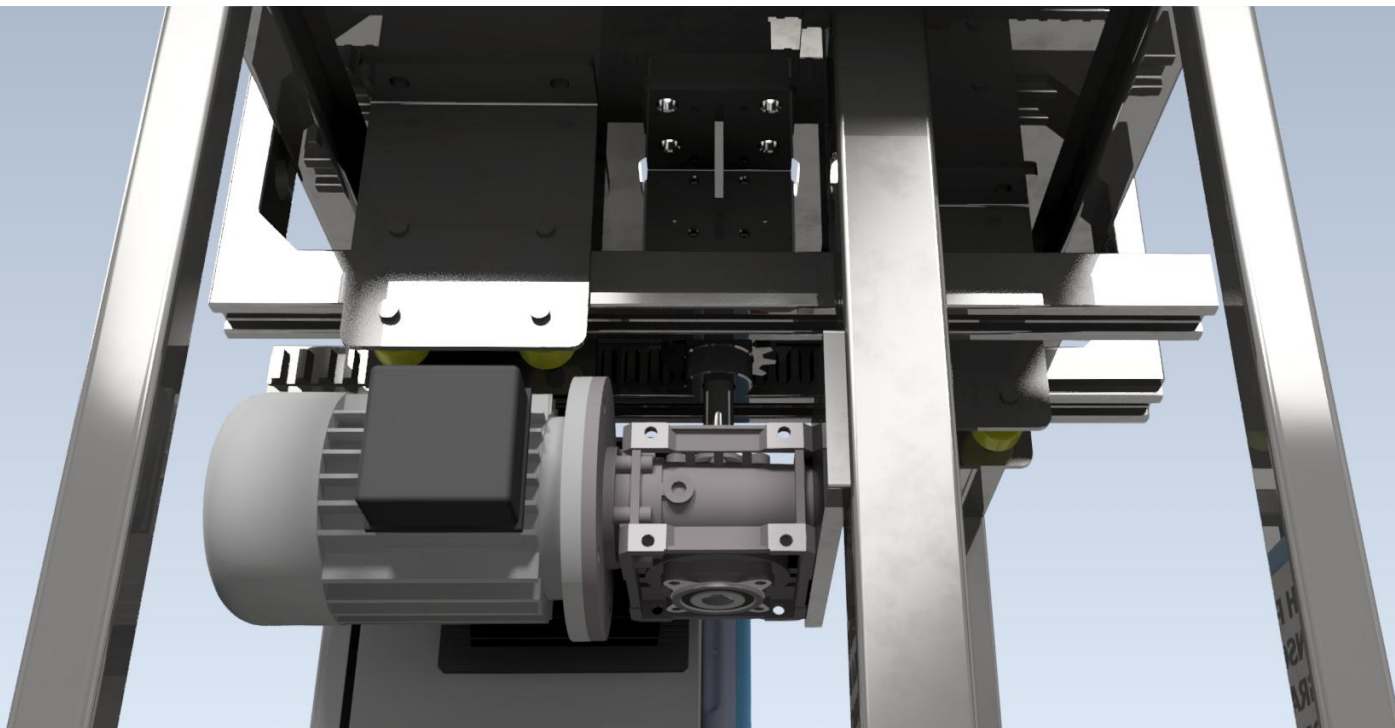
IGPS<sup>®</sup>

Empresa:

Representaciones / Alianzas Estratégicas:



TRDAX

IGPS<sup>®</sup> ROBOTICA

Arisens

XOLERTIO

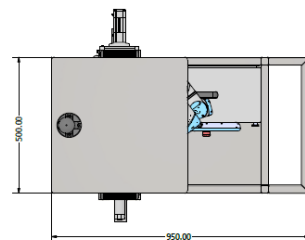
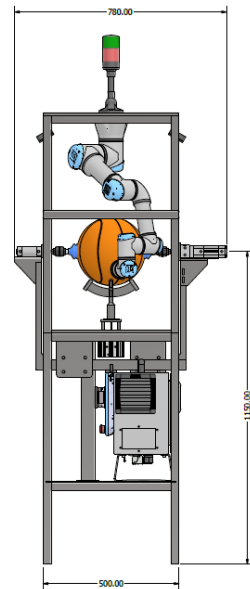
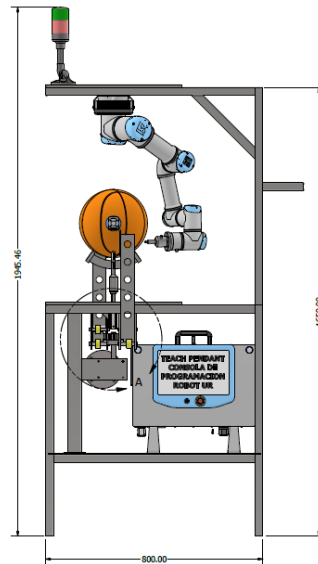
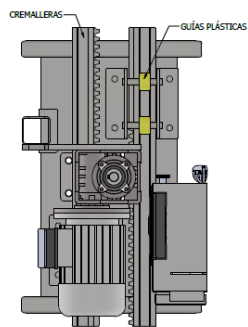
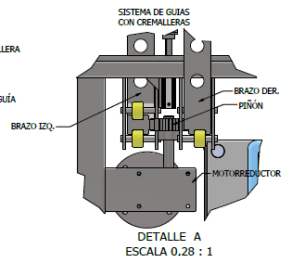
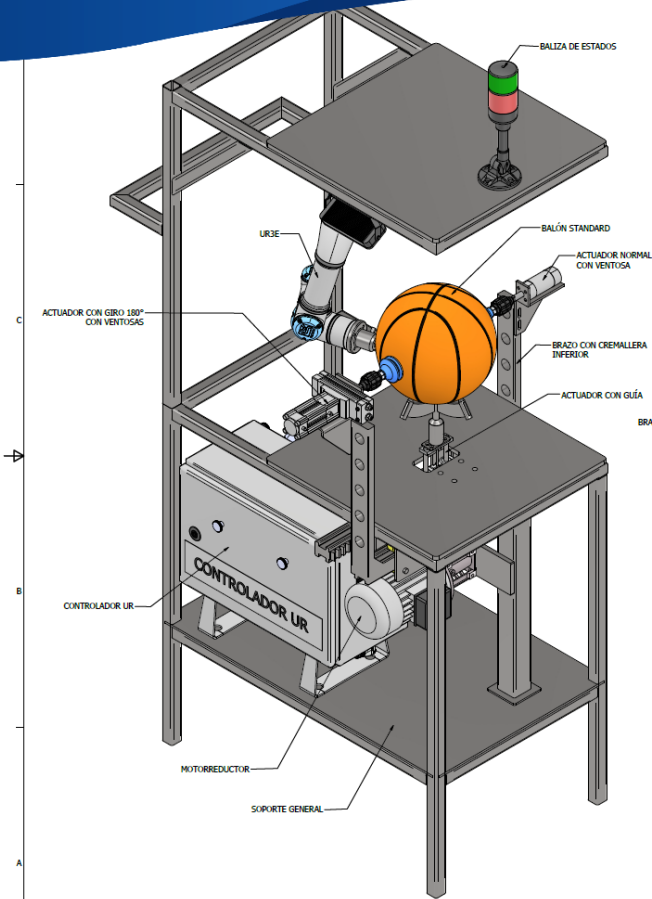

DISEÑADO: Rodrigo Suleis Rivera REVISADO: Isidoro Gomez DTA	03/06/2025 03/06/2025	<b>GRUPO IGPS</b>
TÍTULO: OA25067 (2) GRUPOY Co RyD Balones v1.0		
DISEÑADO: Isidoro Gomez	03/06/2025	
ANÁLISIS: D ESCALA: 1 / 4	DWG NO: OA25067 (2) GRUPOY v1.0 A	Hoja 1 DE 2

**Opción 2**  
**Estación Colaborativa Automática**  

---



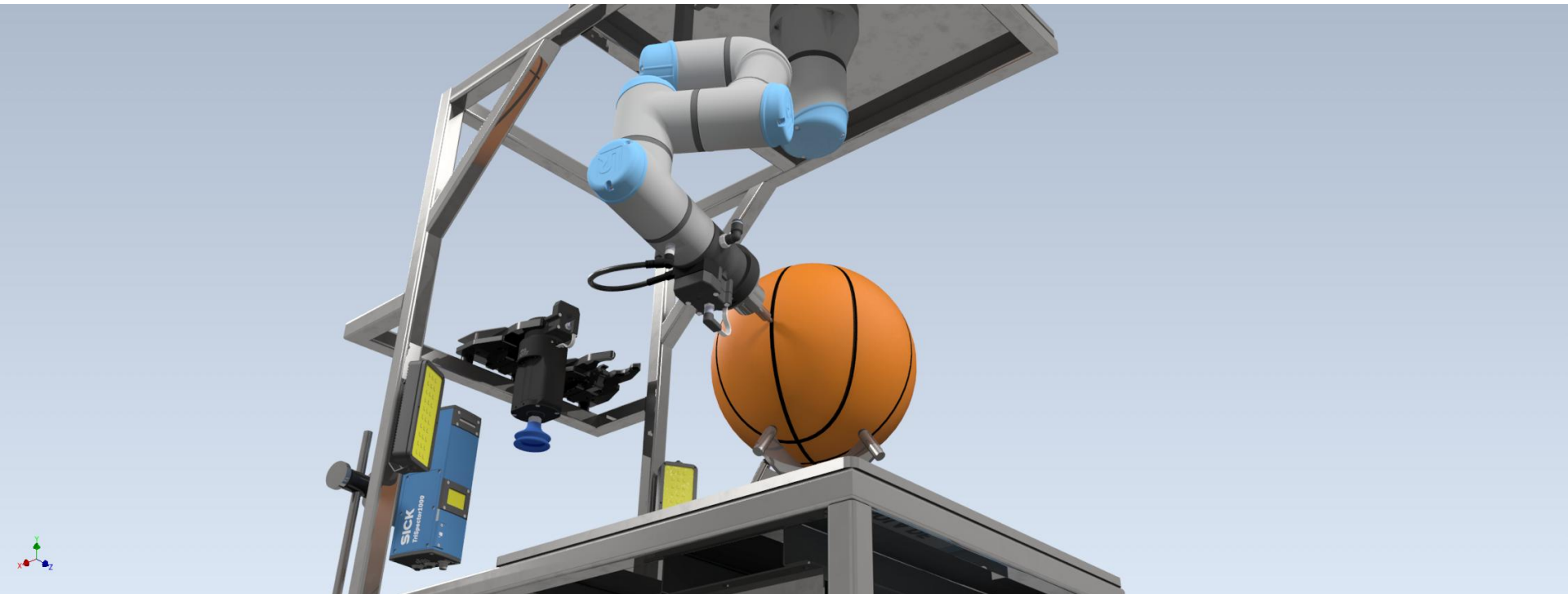

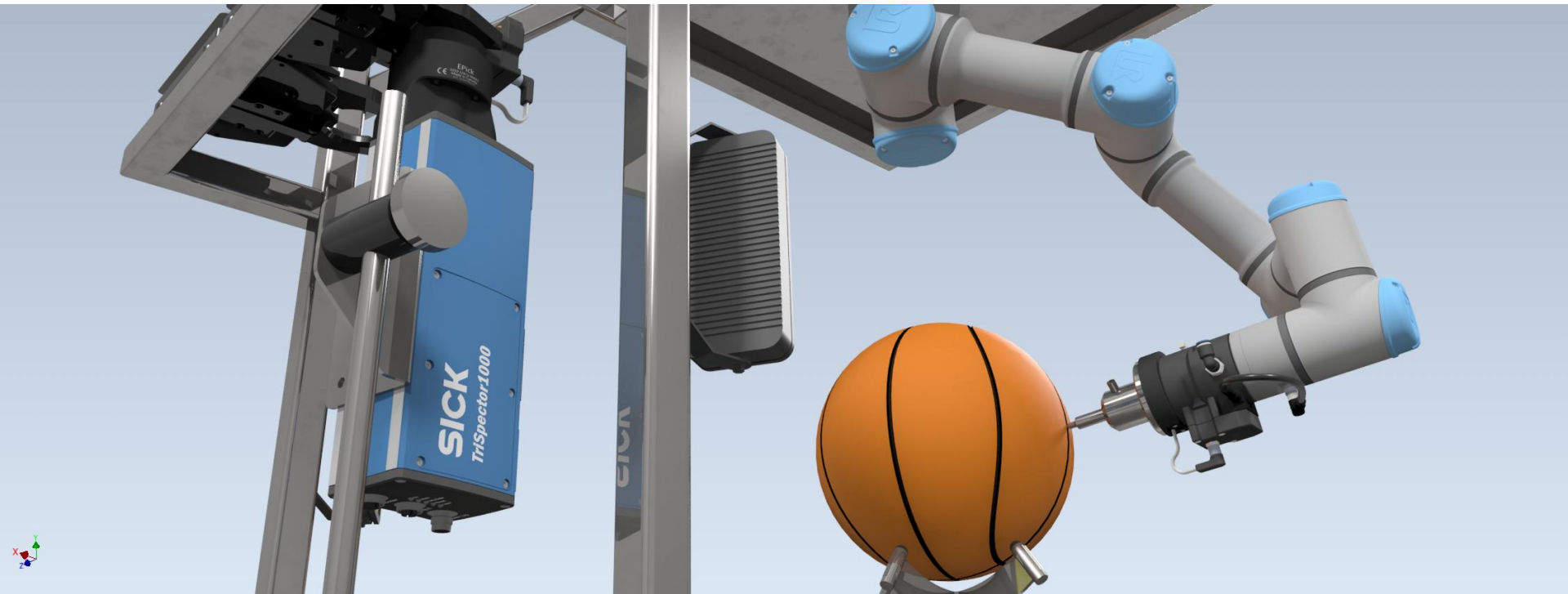

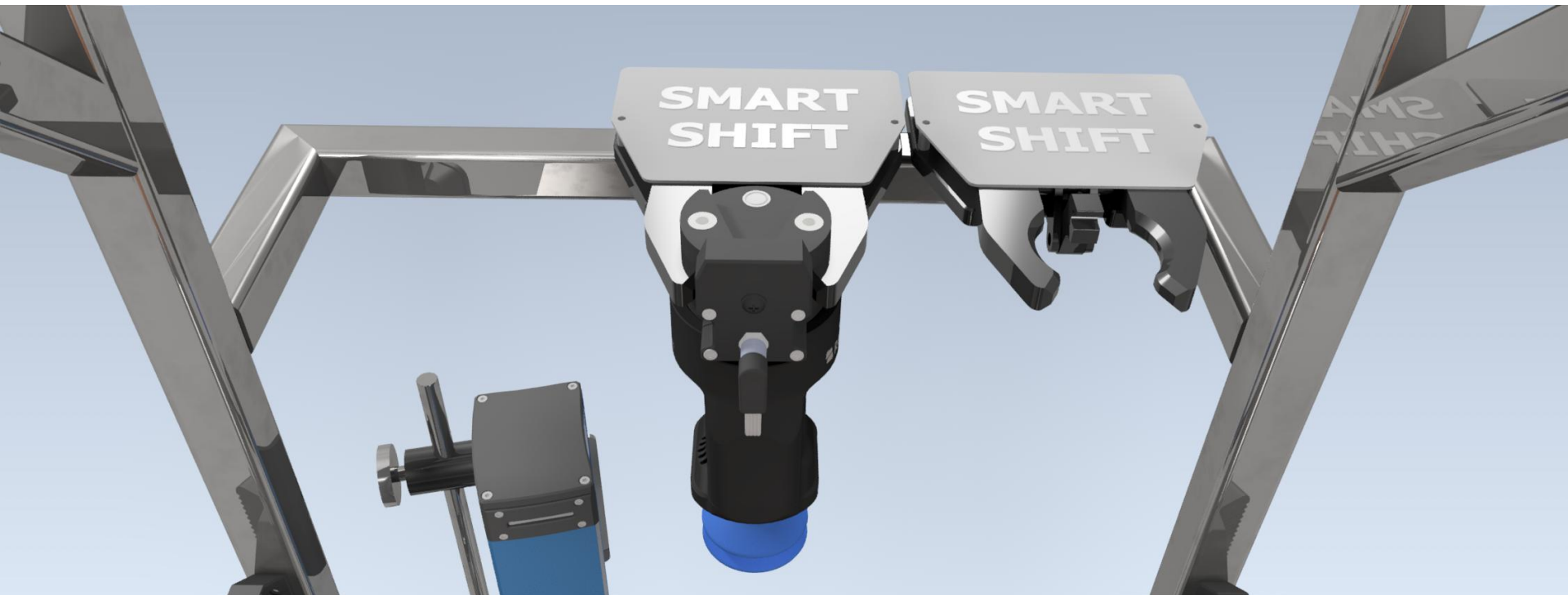
IGPS<sup>®</sup>

Empresa:

Representaciones / Alianzas Estratégicas:



TRDAX

IGPS<sup>®</sup>

ROBOTICA

Arisens

XOLERTIO

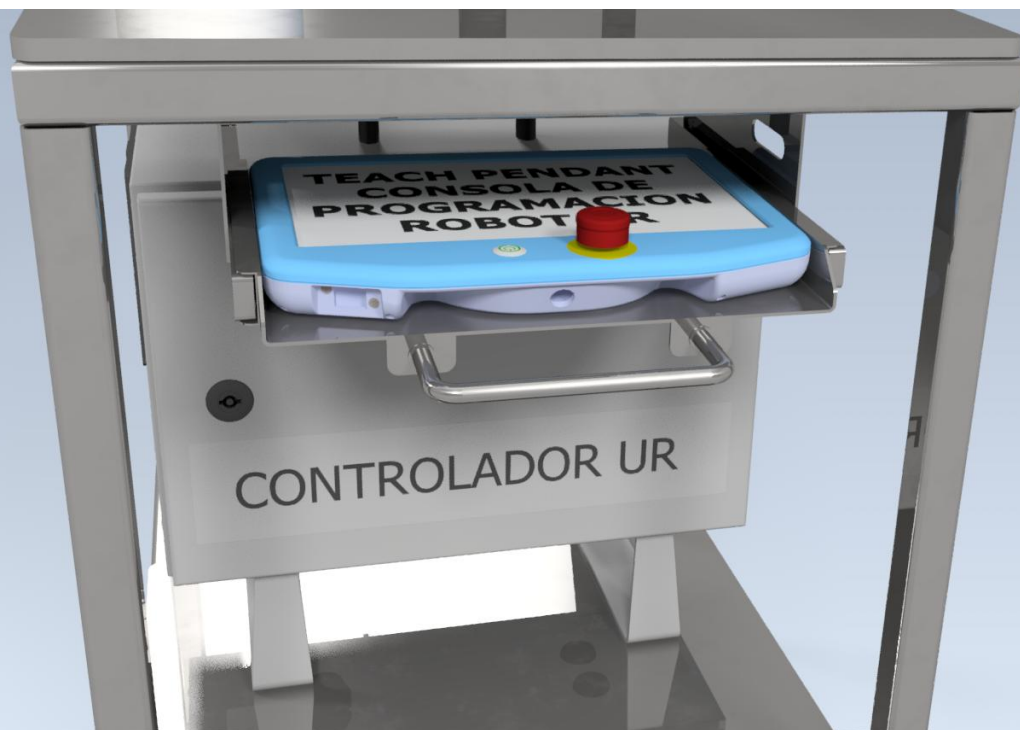
IGPS<sup>®</sup>

Empresa:

Representaciones / Alianzas Estratégicas:



TRDAX

IGPS<sup>®</sup>

ROBOTICA

Arisens

XOLERTIO

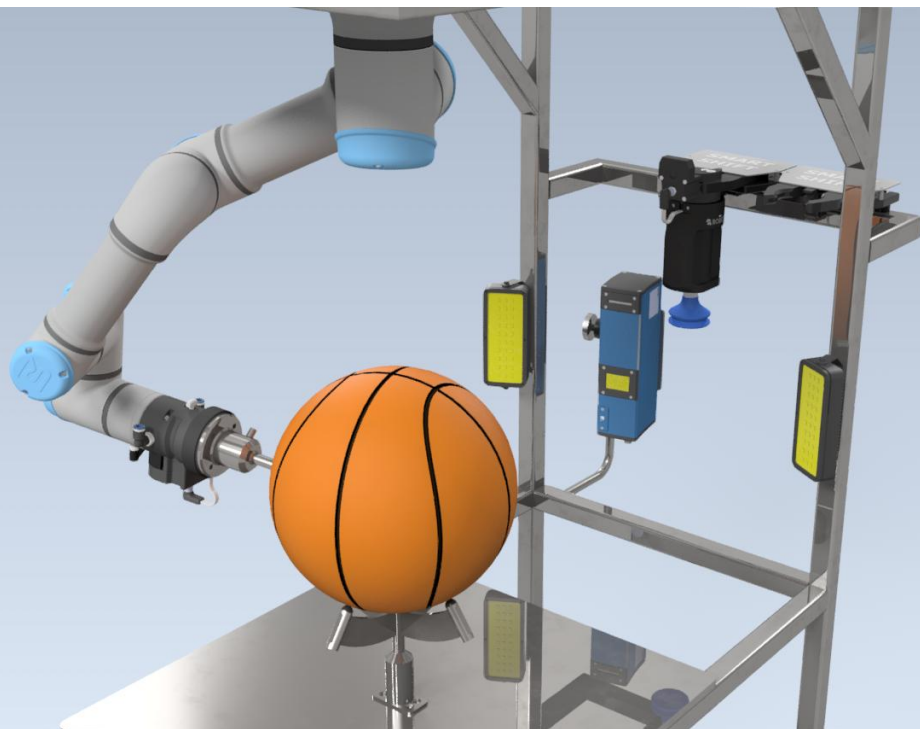
IGPS<sup>®</sup>

Empresa:

Representaciones / Alianzas Estratégicas:



TRDAX

IGPS<sup>®</sup>

ROBÓTICA

Arisens

XOLERTIO

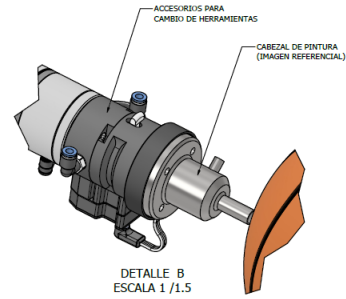
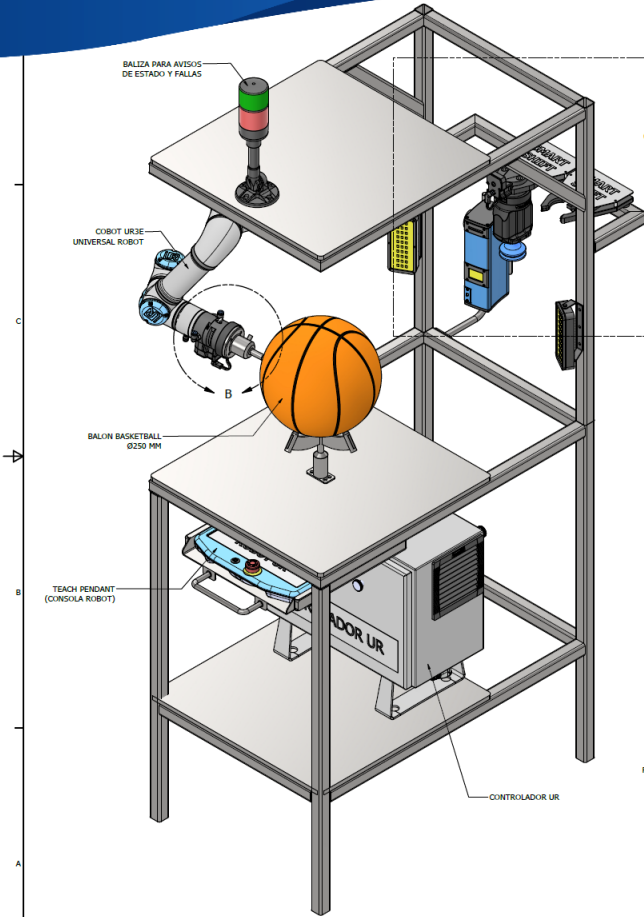

DETALLE B  
ESCALA 1 / 1.5

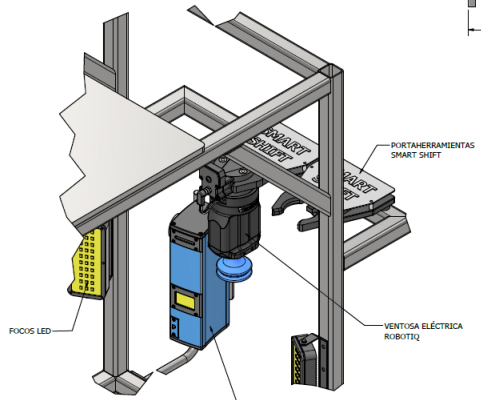

DETALLE C  
ESCALA 1 / 3

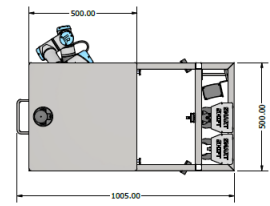
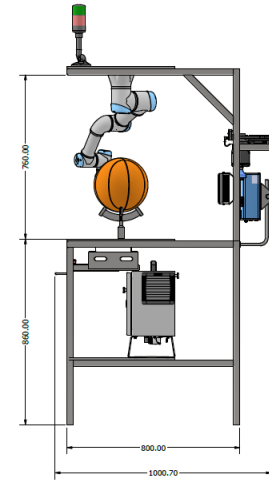
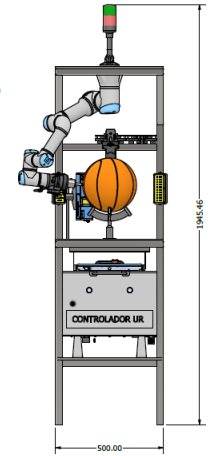











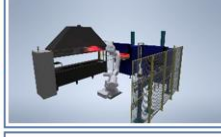

DISEÑADO: Rodrigo Salas Rivera REVISADO: Isidoro Gomez UR		03/06/2025 03/06/2025	<b>GRUPO IGPS</b>  TÍTULO: OA25067 (2) GRUPOY Co RyD Balones v1.0
DISEÑADO: Isidoro Gomez		03/06/2025	
		ZONA D ESCALA: 1 / 4	DWG NO OA25067 (2) GRUPOY v1.0 A HOJA 2 DE 2

Contacto



# Contacto

<b>Seguridad de Máquinas Robótica Colaborativa</b>	<b>Robotizaciones Especiales</b>	<b>Distribuciones Ind 4.0 Simulación   Soporte</b>	<b>Final de Línea Paletizado</b>	<b>Eneajado Estuchado</b>
				
<b>Vallados Seguridad Automatización y Robótica   Logística</b>				
				

Escaneado BIN CIM  
Ingeniería Inversa  
Metrología  
3D Fotogrametría



Empresas:

Representaciones / Alianzas Estratégicas:



Isidoro Gómez  
CRO  
✉ isidoro.gomez@igps.es  
☎ +56 9 3197 5128

Apoquindo 5950. Piso 18. Oficina 18-110.  
Las Condes. Santiago RM. CHILE  
[www.grupo-igps.cl](http://www.grupo-igps.cl)



Oscar Sandoval  
Commercial manager LATAM  
✉ osandoval@igps.es  
☎ + 57 3218780665

Apoquindo 5950. Piso 18. Oficina 18-110  
Las Condes. Santiago RM. CHILE  
[www.grupo-igps.cl](http://www.grupo-igps.cl)

**Oficina Comercial:** Apoquindo 5950, Piso 18,  
Oficina 18-110 | Las Condes | Santiago | CHILE  
**Email:** [isidoro.gomez@igps.es](mailto:isidoro.gomez@igps.es) |  
[igomez@arisens.cl](mailto:igomez@arisens.cl)

**Email:** [osandoval@igps.es](mailto:osandoval@igps.es)  
**Web:** [www.grupo-igps.cl](http://www.grupo-igps.cl)  
**Cel:** +56 9 3197 5128  
**Cel:** +57 3218780665

